

TOSHIBA

Instruction Manual

TIME LAPSE VCR

KV-5024A

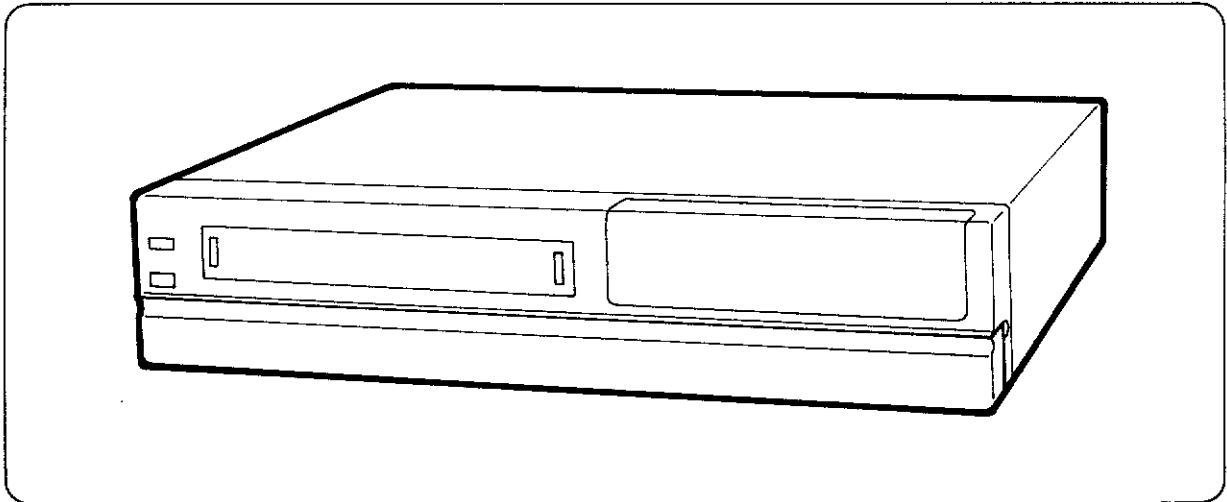

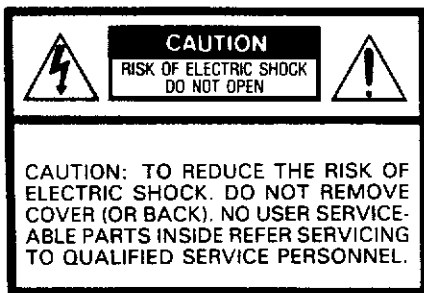

The lightning flash with arrowhead symbol, within an equilateral triangle, is intended to alert the user to the presence of uninsulated "dangerous voltage" within the product's enclosure that may be of sufficient magnitude to constitute a risk of electric shock to persons.

The exclamation point within an equilateral triangle is intended to alert the user to the presence of important operating and maintenance (servicing) instructions in the literature accompanying the appliance.

WARNING: TO REDUCE THE RISK OF FIRE OR ELECTRIC SHOCK, DO NOT EXPOSE THIS APPLIANCE TO RAIN OR MOISTURE. DANGEROUS HIGH VOLTAGES ARE PRESENT INSIDE THE ENCLOSURE. DO NOT OPEN THE CABINET. REFER SERVICING TO QUALIFIED PERSONNEL ONLY.

NOTE: This equipment has been tested and found to comply with the limits for a Class A digital device, pursuant to Part 15 of the FCC Rules. These limits are designed to provide reasonable protection against harmful interference when the equipment is operated in a commercial environment. This equipment generates, uses, and can radiate radio frequency energy and, if not installed and used in accordance with the instruction manual, may cause harmful interference to radio communications. Operation of this equipment in a residential area is likely to cause harmful interference in which case the user will be required to correct the interference at his own expense.

In the spaces provided below, record the Model and Serial No. located at the rear of your video cassette recorder.

Model No. _____ Serial No. _____

Retain this information for future reference.

Important Precautions

Only cassettes marked **VHS** can be used with the VCR.

This VCR is not compatible with ordinary **VHS** VCRs.

Save Original Packing Materials

The original shipping carton and packing materials will come in handy if you ever have to ship your VCR. For maximum protection, repack the set as it was originally packed at the factory.

Surface Damage

This VCR is covered with a clear plastic, to protect the top cover surface during shipping and handling. Daily wear may result in dents or cracks in the plastic which appear as white marks or other kinds of apparent surface damage. This does not mean that your VCR itself is damaged. If damage to this coating is extensive, simply peel it off.

Moisture Condensation

Never operate this unit immediately after moving it from a cold location to a warm location. When the VCR is exposed to such a change in temperature, moisture may condense on the cylinder inside it, one of its most crucial internal parts. The unit is equipped with an automatic moisture condensation prevention circuit designed to cope with this problem. It takes about **TWO HOURS** for this circuit to work with the power cord plugged in. Please do not use the VCR during this time.

Daily Maintenance

Before beginning the day's operation, rewind the cassette tape recorded on the previous day a few counts and play it back to check for proper recording.

Copyright

To record video tapes and other material only in the event that third party copyrights and other rights are not violated.

Features

This VCR Time Lapse Recorder features recording for 2, 12, 24 hours with audio using T-120 cassette. This recorder employs 2 heads which have the same azimuth to allow slow playback and still playback. It also features various playback functions, such as picture search, and reverse picture search.

- **REAL TIME MODE**
Recordings may be made in the 2 hour real time mode.
- **TIME LAPSE MODE**
Recordings may be made in speeds of 12, 24 hours using a T-120 cassette.
- **NOISE FREE STILL PLAYBACK**
The use of a 2-head having the same azimuth mechanism provides clear, noise free still playback. However, if a tape recorded in 2-hour record mode is played back, noise may appear slightly in the upper and lower part of the screen.
- **TIME DATE GENERATOR**
The built-in time date generator superimposes the Month, Day, Year, Day of Week, Hour, Minute, Second, Mode, and Alarm input time on the picture. It may be positioned to avoid interfering with critical areas of the picture. A battery backup protects the program memory against power failures for up to 7 days.
- **ALARM RECORDING**
An alarm input may be set to activate the 2-hour record mode for 15 seconds, 30 seconds, or 3 minutes.
- **ALARM MEMORY**
The starting position of alarm recordings may be automatically located by using the ALARM MEMORY mode. Once the position is located, this VCR enters the PLAY mode in PAUSE for immediate viewing.
- **RECORD MODE LOCK**
A **REC LOCK/RESTART** switch is provided to prevent unauthorized use of the recorder.
- **POWER FAILURE RESTART**
With the **REC LOCK/RESTART** switch in the ON position this VCR will automatically return to the record mode selected prior to a power failure.
- **SELECTIBLE AUTO REPEAT RECORDING**
This VCR may be placed into a repeat recording mode so that when the tape reaches the end it will be rewound automatically and recording resumed.
- **PROGRAMMABLE TIMER RECORDING**
This VCR can be programmed for 15 programs in total for timer recording: two programs per day plus one for a specified time of a day throughout the week. It is also provided with a skip function that can skip programmed contents where no recording is wanted.
- **ELECTRONIC BUZZER**
An electronic buzzer is provided to indicate various conditions such as the end of tape; the start of alarm recording; excessive moisture (dew); or invalid entries.
- **DISPLAY PANEL**
All modes of operation and conditions are displayed on the display panel.
- **10000 HOUR METER**
A 10000 hour meter is provided which indicates the total time this VCR has been in operation.

Table of Contents

	Page		Page
Important Precautions	1	Basic Manual Recording	12
Accessories	2	Recording in Various Ways	13
Features	2	Alarm Recording	14
Table of Contents	2	Basic Playback	15
Location of Controls	3	Playback in various ways	15
Front panel	3	Playback adjustment procedure	16
Rear panel	5	Playback of alarm recording	16
Mode display	6	Maintenance	17
Time Date Generator	7	Before Calling Service Personnel	18
Setting to the current time	9	Specifications	21
How to program the timer	10		
How to Select a Time Mode	11		
Loading and Unloading a Video Cassette	11		

Accessories

- Dew Caution Sheet
- Safety Instruction

Location of Controls

[Front Panel]

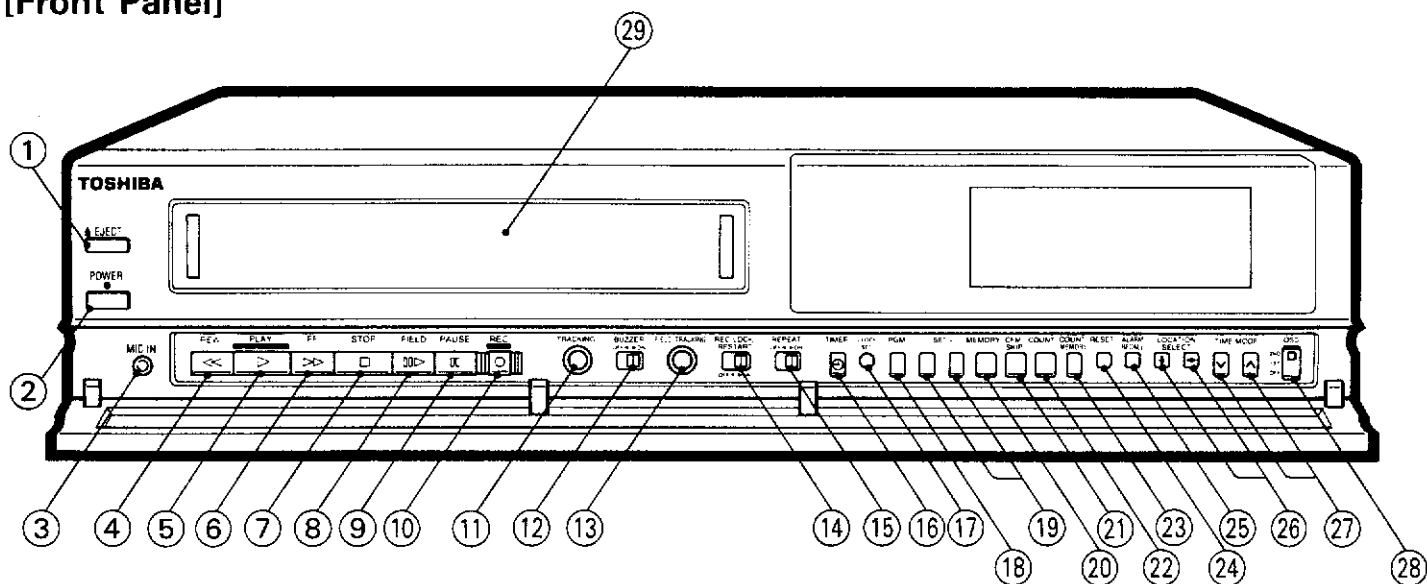

- ① **EJECT button**
When pressed, the cassette is automatically ejected from the cassette compartment.
- ② **POWER button**
Turns this VCR's power on and off. When off, the display panel will show "OFF". The **POWER** button is disabled while in the record lock mode or in the alarm record mode.
- ③ **MIC IN jack**
When using this microphone jack as an audio input, the RCA jack input will be switched off.
- ④ **REW/REVERSE PICTURE SEARCH button**
Pressing the **REW** button with the tape stopped causes the tape to be rewound. Pressing the **REW** button during playback causes the picture to be played back at 5 times the normal speed in the reverse direction.
- ⑤ **PLAY button**
Pressing the **PLAY** button starts the playback mode.
- ⑥ **FF/FORWARD PICTURE SEARCH button**
Pressing the **FF** button with the tape stopped causes the tape to be fast-forwarded. Pressing the **FF** button during playback causes the picture to be played back at 5 times the normal speed in the forward direction.
- ⑦ **STOP button**
Pressing the **STOP** button while in the playback or record will cancel the mode.
- ⑧ **FIELD button**
While in the playback mode, single frames may be viewed by field pressing the **PAUSE/STILL** button and then advancing field by pressing the **FIELD** button. Keep the button pressed to play back at about 1/30 of the normal speed.
- ⑨ **PAUSE button**
Pressing the **PAUSE** button while in the record mode stops tape movement and recording. Pressing the **PAUSE** button while in the playback mode stops the tape and displays a still picture. Pressing the **PAUSE** button twice cancels this mode.
- ⑩ **REC button**
Pressing the **REC** button will begin recording in the mode selected.
- ⑪ **TRACKING control**
Rotating this control while in the 2-hour playback mode will eliminate tracking noise from the picture.
- ⑫ **BUZZER switch**
This switch is the on/off switch for the buzzer. The buzzer will sound in different ways depending on that condition. If there is moisture in the heads (DEW) the buzzer will sound continuously. When the tape reaches its end in the record mode, the buzzer will sound continuously. The buzzer may be cancelled by pressing this button. The buzzer will beep five times if recording is attempted with the record protect tab removed or when the timer button is pressed.
- ⑬ **FIELD TRACKING control**
Rotating this control while in any field advance mode will eliminate tracking noise from the picture.
- ⑭ **REC LOCK/RESTART switch**
Setting the **REC LOCK/RESTART** switch to the "ON" position will disable all controls while in the record mode, thereby protecting against unauthorized or accidental termination. In the event of a power failure this VCR will automatically resume recording when power is restored. Setting the **REC LOCK/RESTART** switch to the "OFF" position cancels these functions. See page 13.
- ⑮ **REPEAT switch**
The record mode may be set so that when the the tape reaches the end it will be rewound and resume recording. This is accomplished by setting the **REPEAT** switch to the "ON" position.
- ⑯ **TIMER button**
This button is used to begin timer recording after they have been programmed.

Head cleaner and power fails display

- A head cleaning unit is provided to prevent the head from being clogged. The head cleaner automatically starts cleaning the head when the tape end is detected for about 40 seconds. During cleaning the cassette mark blinks several times. Rest assured this is not a defect.
- When the tape end is detected, an electric buzzer sounds and the counter display blinks. To stop the blinking, press any button.
- When power fails, the "PW.FAIL" mark blinks on the display. Press any button to erase the mark.

17 CLOCK SET button

This button is used to program the time. (Refer to detailed programming instructions.)

18 PGM button

This button is used program the timer. (Refer to detailed programming instructions.)

19 SET (-)/(+) button

These buttons are used to program the time or timer. (Refer to detailed programming instructions.)

20 MEMORY button

This button is used to program the time or timer. (Refer to detailed programming instructions.)

21 CFM/SKIP button

Pressing the **CFM** (confirm) button while in the stop mode causes the contents of the timer memory to be shown on the on-screen display. Press this button in timer setting mode. "SKIP" is displayed where programmed times were, and the program will be skipped for recording. Press it again to display the programmed times.

22 COUNT. button

Pressing the **COUNT.** button displays the tape counter or the alarm counter on the MODE DISPLAY.

23 COUNT. MEMORY button

Pressing the **COUNT. MEMORY** button causes the "COUNT. M" (counter memory) to appear on the MODE DISPLAY. If the tape is fast-forwarded or rewound while in this mode the tape will stop automatically at a count of "0000". Pressing this button twice causes the "ALARM M" (alarm memory) to be displayed. If the tape is fast-forwarded or rewound while in this mode the tape will stop automatically at the beginning of an alarm and enter the STILL, PLAYBACK mode. Pressing the button three times cancels this function.

24 RESET button

- Pressing the **RESET** button while in the tape counter mode resets the tape counter to "0000". Pressing the **RESET** button while in the alarm counter mode resets the alarm counter to "A-00".
- Press this button to release the alarm recall that has been recorded. (max 5 programs)

25 ALARM RECALL button

Pressing the **ALARM RECALL** button while in the stop mode will begin an on-screen review of all alarms which have been recorded. Each alarm will be displayed along with the time and date associated with that alarm of 5 seconds. During this sequential display period the **SET (+)** and **SET (-)** buttons may be used to advance or recall the alarms displays.

26 LOCATION SELECT buttons

Pressing these buttons will position the on-screen display. The display will move in the direction of the arrows marked on the buttons. When the display reaches the border of the picture it will "wrap around" to the other side.

27 TIME MODE buttons

These buttons are used to select recording speed. Pressing the button marked with the up or down arrow will increase or decrease the record speed which will be shown on the display panel.

28 ON-SCREEN DISPLAY switch

This switch allows you to select how much information appears in the on-screen display. In the "OFF" position the entire display is off. In the "1ST" position only one line containing time and alarm information will be displayed. In the "2ND" position a second line containing date information will be displayed.

29 CASSETTE COMPARTMENT

When a cassette is inserted into the cassette compartment, the mechanism will automatically load the tape into this VCR.

Location of Controls

[Rear Panel]

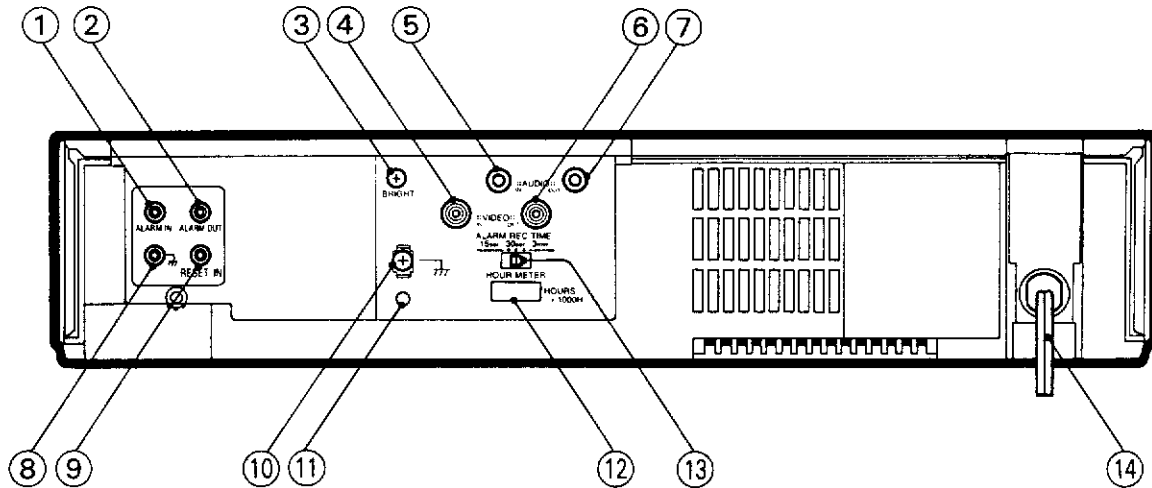

- ① **ALARM IN terminal**
An alarm to ground at this terminal begins the alarm mode recording sequence.
- ② **ALARM OUT terminal**
This terminal outputs alarm signals.
- ③ **BRIGHT control**
The on-screen display brightness may be set by rotating the BRIGHT control.
- ④ **VIDEO IN jack**
This BNC jack is a terminated video input.
- ⑤ **AUDIO IN jack**
This RCA jack is an audio line input.
- ⑥ **VIDEO OUT jack**
This BNC jack is a video output used to drive a monitor, switcher, or other equipment.
- ⑦ **AUDIO OUT jack**
This RCA jack is an audio line output used to drive other audio equipment.
- ⑧ **GROUND terminal**
This is the ground terminal for the alarm input.
- ⑨ **RESET IN terminal**
Ground at this terminal will cancel an existing alarm recording sequence.
- ⑩ **GROUND terminal**
This terminal is used to connect other equipment.
- ⑪ **ALL CLEAR button**
 - Pressing this button will clear the entire time/date, and timer program memory. The power will be turned off at the same time. Pressing the **POWER** button will restore power.
 - Press this button if the VCR malfunctions.
- ⑫ **10000 HOUR meter**
The 10000 HOUR meter displays the total number of hours this VCR has been in service.
- ⑬ **ALARM REC TIME switch**
The **ALARM REC TIME** switch is used to set the alarm recording time to 15 seconds, 30 seconds, or 3 minutes.
- ⑭ **POWER CORD**

[Mode Display]

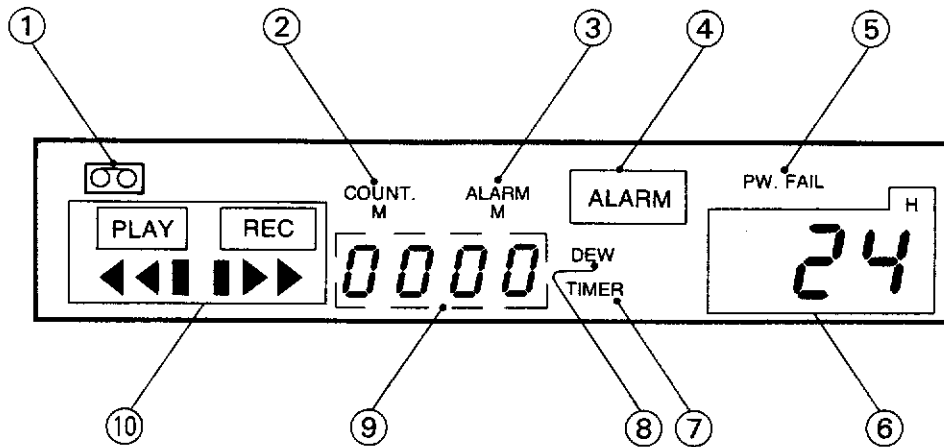

- ① **Cassette Display**
This indicator lights when a cassette is loaded.
- ② **Counter Memory Display**
This display lights when the counter memory is in use.
- ③ **Alarm Memory Display**
This display lights when the alarm memory is in use.
- ④ **Alarm Display**
This display lights when an alarm recording occurs.
- ⑤ **Power Failure Display**
This display lights when power failure occurs.
- ⑥ **Recording/Playback Time Display**
Recording/playback time mode is displayed.
- ⑦ **Timer Display**
This display lights when the **TIMER** button is pressed.
- ⑧ **Condensation Display**
This display flashes if moisture condenses inside the unit.
- ⑨ **Counter/Alarm Counter Display**
Either the counter display or the alarm counter display can be given by use of the counter/alarm counter selector button.





⑩ **Mode Display**
The display will be given as follows depending on the control mode.

Playback ..	PLAY ▶	Recording ...	REC ▶
Still	PLAY II	Pause	REC II
Field		Time Lapse..	REC I▶
Advance ..	PLAY II▶	Fast-	
Forward		Forward	▶▶
Picture		Fast-	
Search....	PLAY ▶▶	Rewind	◀◀
Reverse		Abnormality	indicator
Picture		detected....	flashes
Search....	PLAY ◀◀		

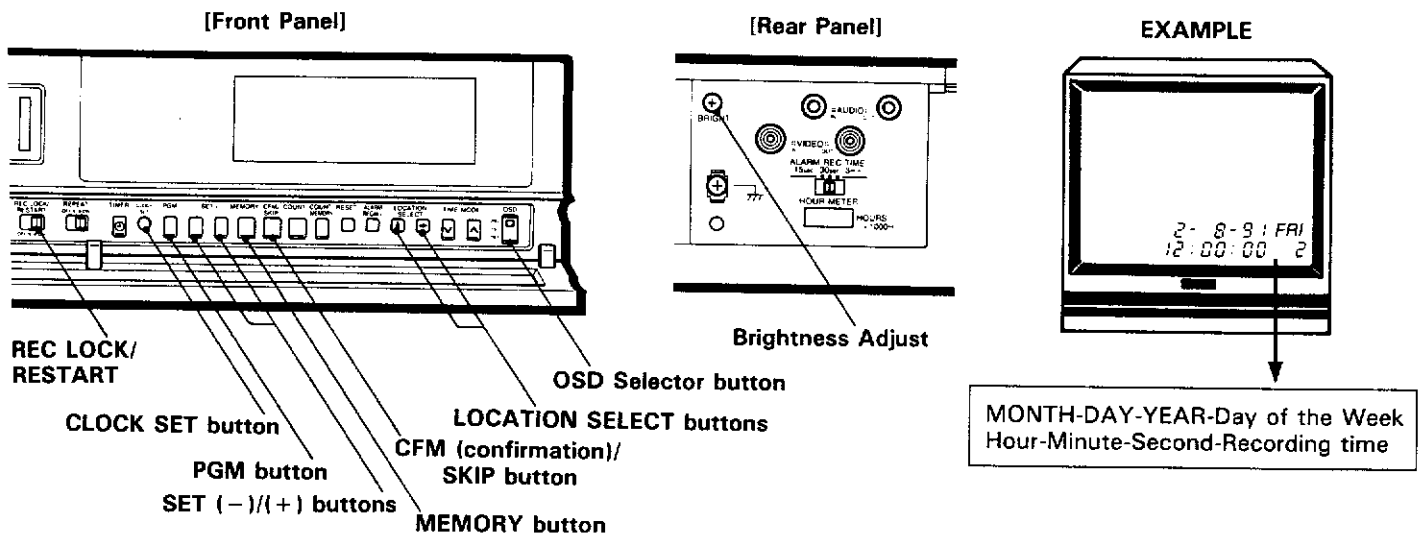
Time Date Generator

Time and date display will not appear without a video input.

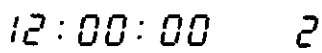

Control	Operation	Function
OSD Selector button	Set the switch to 2ND.	Date and time will appear on 2 lines on a TV screen.
		
	Set the switch to 1ST.	Time will appear on one line. For alarm recording, time setting or timer programming, 2 lines will appear.
LOCATION SELECT buttons		
	Set the switch to OFF.	No display will appear. For alarm recording, time setting or timer programming, display will be on 2 lines.
Brightness Adjustment control		
	To set brighter, turn the control clockwise, and to set darker, turn it counterclockwise. Use a small screwdriver to adjust.	Brightness of the background is adjusted for easy reading of characters displayed on the TV screen.

Control	Operation	Function
CLOCK SET buttons	Press the button to set the time.	When the button is pressed, the position indicating the day will blink on the TV screen. Using the SET button and MEMORY button, set the calendar and time.
PGM (Program) button	Press the button to program the timer.	<ul style="list-style-type: none"> • When the button is pressed, calendar display will change to the program display on the TV screen. Using the SET button and MEMORY button, set the recording day, start and stop time. • Two reservations can be programmed for each day of the week, from Monday to Sunday. • Daily programming is available.
SET - button	Press the button to set the time and program the timer.	<ul style="list-style-type: none"> • When the button is pressed, the display will advance in the reverse direction. • When the button is held down, the display will change continuously.
SET + button	Press the button to set the time and program the timer.	<ul style="list-style-type: none"> • When the button is pressed, the display will advance in the normal direction. • When the button is held down, the display will change continuously.
MEMORY button	Press the button to store the display to be set.	When the button is pressed, the figures displayed on the TV screen will be stored in the memory. Then, the display will move to the next character to be set, and blink.
CFM (Confirmation)/ SKIP button	To confirm the timer programming, stop the VCR and press this button.	Pressing this button displays the programmed contents on the TV screen. Pressing the SET button enables the programmed contents to be changed. Press the CFM/SKIP button to return to the calendar display on the screen.
	To clear the timer programming, press PGM (program) button to display PGM mode, and press this button	Press the SET button to display the unwanted program for recording. Press the CFM/SKIP button. The "SKIP" indicator replaces the recording start and end times. The program will not be recorded. Press the button again to return to display the programmed recording start and end times.

Setting to the Current Time

Setting outline: Press the **SET** (-)/(+) button to the desired alphanumeric characters at the blinking position, and then press the **MEMORY** button to store these characters in memory.
For example, setting to 17:35 (5:35 PM), February 8 (Fri), 1991 from 12:00, January 28 (Mon), 1991.

- ① Press the **CLOCK SET** button.

	DISPLAY ON TV
	<pre> 1-28-91 MON 12:00:00 SET </pre>

- ② Press the **SET** button to set the 2 MONTH.

	DISPLAY ON TV
	<pre> 2-28-91 MON 12:00:00 SET </pre>

When the + button is pressed...

→ 1→2→3→4→ 12 →

When the - button is pressed, the direction is reversed.

- ③ Press the **MEMORY** button.

	DISPLAY ON TV
	<pre> 2-28-91 MON 12:00:00 SET </pre>

- ④ Press the **SET** button to set the 8 DAY.

	DISPLAY ON TV
	<pre> 2-8-91 MON 12:00:00 SET </pre>

- ⑤ Press the **MEMORY** button.

	DISPLAY ON TV
	<pre> 2-8-91 MON 12:00:00 SET </pre>

- ⑥ The year remains unchanged, so press the **MEMORY** button to store it in memory.
(Note) To change the setting of the year, press the **SET** button to obtain the desired number, and then press the **MEMORY** button to store this number in memory.

	DISPLAY ON TV
	<pre> 2-8-91 MON 12:00:00 SET </pre>

- ⑦ Press the **SET** button to set the FRIDAY.

	DISPLAY ON TV
	<pre> 2-8-91 FRI 12:00:00 SET </pre>

When the + button is pressed...

→ MON→TUE→WED→THU→FRI→SAT→SUN →

When the - button is pressed, the direction is reversed.

- ⑧ Press the **MEMORY** button.

	DISPLAY ON TV
	<pre> 2-8-91 FRI 12:00:00 SET </pre>

- ⑨ Similarly, set the hour and the minute. Seconds cannot be set.

- ⑩ After setting the minute, press the **MEMORY** button so that the month blinks as shown below.

<pre> 2-8-91 FRI 17:35:00 SET </pre>
--

- ⑪ Press the **CLOCK SET** button to end this procedure.

	DISPLAY ON TV
	<pre> 2-8-91 FRI 17:35:01 2 </pre>

Pressing "CLOCK SET" starts the clock.

This may be done to set the clock to the exact time.

The generator will automatically determine correct dates and leap years.

How to Program the Timer

(Before programming the timer, check to see if the current time is correct. If not, adjust the time according to the descriptions given on the preceding page.)



Setting outline: Press the **SET** button to the desired alphanumeric characters at the blinking position, and then press the **MEMORY** button to store these characters in memory.

For example, to record in 24-hour mode from 18:30 (6:30 PM) to 8:30 (8:30 AM) the next day, MO1 (Monday Program 1)

- ① Press the **PGM** button.

PGM 	DISPLAY ON TV MO1 : - - : - - ON 2 : - - : - - OF
--	---

- ② Press the **SET** (-)/(+) buttons to set it to the programmed day of the week.

-SET+  	DISPLAY ON TV MO1 : - - : - - ON 2 : - - : - - OF
--	---

When the + button is pressed...

→MO1→MO2→TU1→.....SU2→DAY

When the - button is pressed, the direction is reversed.



MO1 : Monday 1 Program
MO2 : Monday 2 Program
DAY : Daily

One setting allowed in each of these 15 groups.



- ③ Press the **MEMORY** button.

MEMORY 	DISPLAY ON TV MO1 : : : - - ON 2 : - - : - - OF
---	---

- ④ Similarly, set the starting hour and minute as well as the ending hour and minute using the **SET** button and **MEMORY** button.

-SET+ MEMORY   	DISPLAY ON TV MO1 : 18 : 30 ON 2 : 8 : 30 OF
---	--

- ⑤ Press the **TIME MODE** buttons to set the TIME MODE "24".

TIME MODE  	DISPLAY ON TV MO1 : 18 : 30 ON 24 : 8 : 30 OF
--	---

Notes

- To program a reservation for another day, press the **MEMORY** button to blink the position indicating the day of the week, then press the **SET** button to the desired alphanumeric characters. Then repeat the procedures from ② through ⑤.
- To cancel a reservation, press the **CFM/SKIP** button. Press the button again to return to display the programmed recording start and end times.

CFM/SKIP 	DISPLAY ON TV SA1 : SKIP ON 24 : SKIP OF
--	--

- ⑥ The current time will be displayed if the **PGM** button is pressed.

PGM 	DISPLAY ON TV 2 - 8 - 91 FRI 17 : 53 : 12 24
---	--

- ⑦ Press the **TIMER** button.

The power source is switched off, and "TIMER" flashes on the mode display.

	OFF TIMER
---	--------------

Recording starts when the programmed day and time of week is reached.

Notes

IF A POWER FAILURE SHOULD HAPPEN

- During power failure, "PW.FAIL" appears on the mode display area. Press any button to turn off the display.
- If the power failure lasts less than 7 days, all programmed memory will be retained. This VCR should be plugged into a 120 volt outlet for at least 20 hours to fully charge the internal battery backup.

How to Select a Time Mode

The following table shows the record and playback capability using a T-120 cassette.

Video Record Modes

Mode Display	Record/Playback Available Time	Recording Interval (about)	Sound Record	Tape Running
2	2 hour	1/60 second	Possible	Continuous
12	14 hour	0.12 second	Possible	Continuous
24	26 hour	0.22 second	Possible	Continuous

Notes

- 12 and 24 hours are in time lapse mode.
- All recordings may be played back in any of the time lapse speeds.
- Playing back must be performed in the mode that has been used for recording, otherwise the sound is reproduced abnormally.

Loading and Unloading a Video Cassette

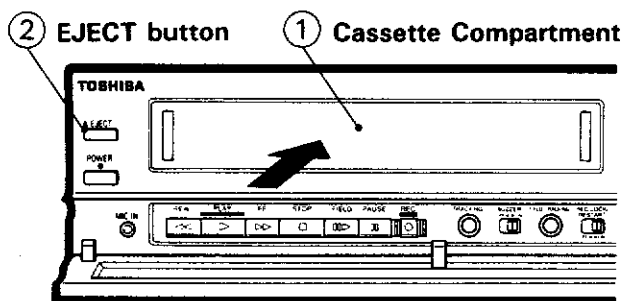

Safety Tab

Preventing tape from erasure of recorded programs

If the safety tab is removed from the tape, the **REC** button is disabled when the tape is loaded on the VCR. Since recording is not operable, pre-recorded programs cannot be erased by mistake.

Remove the safety tab using a screwdriver or another implement with a flat edge.

Loading a Cassette

- ① Insert a cassette into the cassette compartment with the window side facing upward. Push until the cassette is automatically pulled into place. The power is turned on automatically when the cassette is inserted. (Auto power function)



Unloading a Cassette

- ② In the power ON mode, press the **EJECT** button. The cassette tape will be ejected automatically and the cassette indicator "  " will go out.

Safety tab

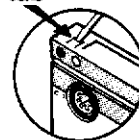

Recording on tape without the safety tab

Cover the hole where the safety tab was with adhesive tape and recording is operable on the tape. To make sure, cover the hole with a double layer of adhesive tape.

Adhesive Tape

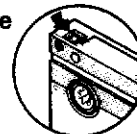

Notes

- Do not insert your hand or a foreign object into the compartment. This may result in injury or damage. Pay special care of children to avoid accidents.
- When a cassette is inside the compartment, the compartment lid does not open.
- The cassette indicator remains on whenever a cassette is inside, even after the power is turned off.
- The cassette indicator flashes when a cassette is being loaded or removed.

Basic Manual Recording

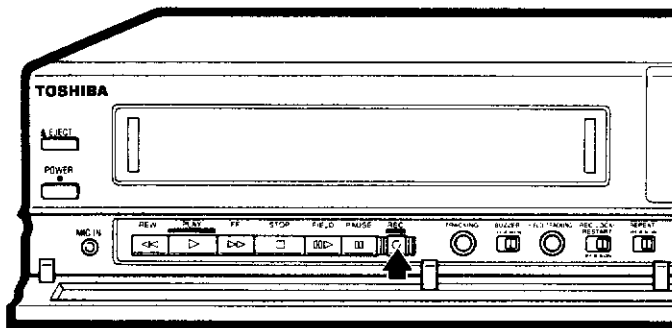
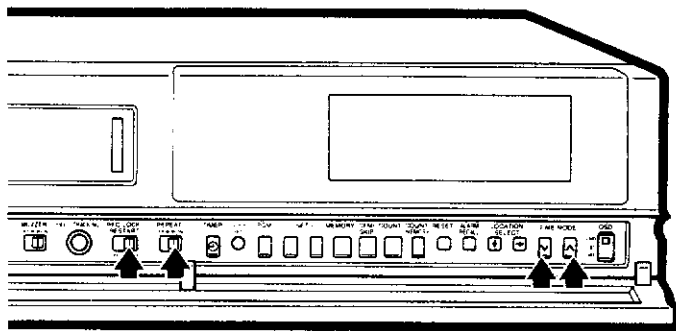
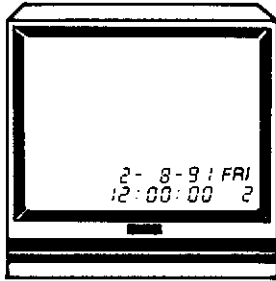

- ① Turn the power ON.
- ② Obtain a picture on the monitor.
- ③ Confirm that time/date is displayed correctly.
- ④ Set the **REPEAT** and **REC LOCK/RESTART** switches as required for recording.
- ⑤ Insert a cassette.
- ⑥ Select the recording time mode.
- ⑦ Press the **REC** button.



To prevent accidental termination, the **REC** button cannot be controlled with a light touch. Press the button firmly and be sure to confirm that **REC** is lit.

Notes

- If the **PAUSE** button is pressed during video recording, the machine will pause. To release it, press the **PAUSE** button again or press the **REC** button. If the pause state continues for longer than 10 minutes, the machine will stop to prevent excessive wear of the tape.
- The functions for auto repeat record, alarm record, etc. should be set prior to video recording.
- Even if a power failure occurs during recording with the **REC LOCK/RESTART** switch set to "ON", recording can be carried out in the same time mode after the power failure is recovered within about one week.
- For repeat video recording, attention must be paid to the following:
 - Alarm recording is unavailable during automatic rewind. No buzzer sound is given even if the tape has reached its end.
 - The repeat function is unavailable if the **STOP** button has been pressed during automatic rewind. The recording state must be restored.
- Do not forget to check the setting of the time/date generator before repeat recording or timer recording.

Recording in Various Ways

This unit employs a multi-function recording system so that it can be widely used for various recording functions. Carefully read the description given here and become familiar with the operation of this unit.

Function	Selection	Operation	Remarks
Record Mode Lock/ Recording after Power Failure	REC LOCK/RESTART switch ON 	<ul style="list-style-type: none"> The record mode is locked during recording so that other buttons and switches cannot operate. 	<ul style="list-style-type: none"> To clear the recording mode, press the STOP button after setting the REC LOCK/RESTART switch to "OFF".
	REC LOCK/RESTART switch center position 	<ul style="list-style-type: none"> * Control enters the recording mode automatically on recovery from a power failure. 	<ul style="list-style-type: none"> ** If the power failure lasts less than 7 days, then the date, time and recording time mode will be stored in the memory, and recording will be resumed automatically after power is restored.
	REC LOCK/RESTART switch OFF 	<ul style="list-style-type: none"> ***The record mode is unlocked so that other buttons and switches can operate. • For recovery from a power failure, take the same procedure as in *. 	<ul style="list-style-type: none"> • Take the same procedure as in ** if recovery from a power failure is within 7 days.
Auto Repeat Recording	Recording on the same cassette repeatedly.	Set the REPEAT switch to "ON".	<ul style="list-style-type: none"> • When the tape end is detected, recording is started again from the beginning of the tape, at the same speed mode that was set originally. • If the power fails during recording, recording mode will be automatically resumed when the power is restored.
Sounding at end of tape	To ensure changing of the cassette	Set the BUZZER switch to "ON".	<ul style="list-style-type: none"> • When the end of the tape is detected, an electronic buzzer sounds continuously, and the counter display blinks. • Press any one of CONTROL buttons to stop the buzzer and blinking of the counter display.
Timer Recording	To record at a specific time by setting weekday and time.	Set the timer recording start and stop time, and weekday. Then press the TIMER button.	<ul style="list-style-type: none"> • Timer recording can be performed for 15 programs in total; two programs for everyday from Monday through Sunday and one program for a specified time of day through the week.



Notes

- Under the following conditions, the recording mode will not be resumed even if the power is restored.
 - A mode other than recording is set with both the **REPEAT** and **REC LOCK/RESTART** switches ON.
- If an alarm signal is entered in AUTO Repeat mode, Repeat Recording is disabled. In this case, press the **ALARM RECALL** button and then press the **RESET** button to reset the alarm counter display.

Alarm Recording

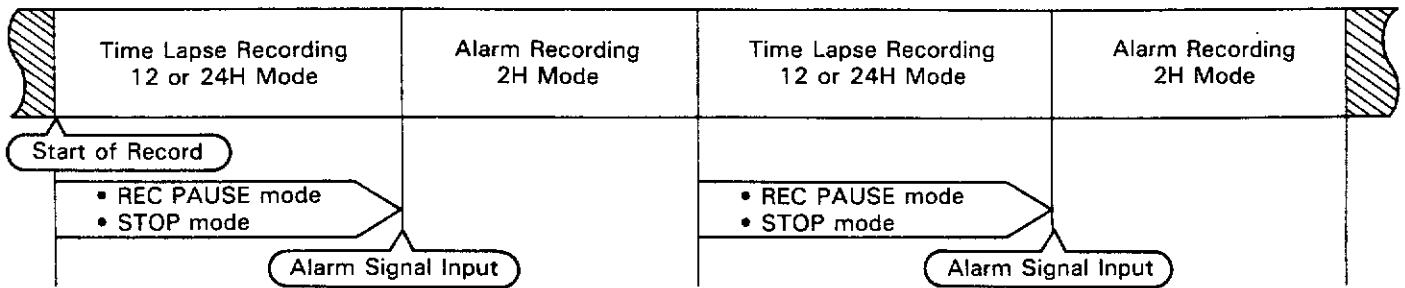
This unit is capable of "Alarm Recording". If the alarm input is connected to a door switch, this VCR will automatically switch from the time lapse mode to continuous recording in the 2-hour mode.

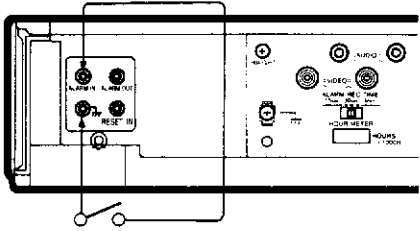

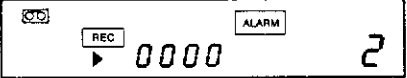
Connection	Operation	Function
<p>The alarm switch is connected as shown below.</p>  <p>Alarm switch</p> <p>Alarm signal input: short circuit * Alarm reset input: short circuit * * The short circuit should last at least 0.5 seconds.</p>	<p>Set the alarm recording time selector switch to the desired recording time length (15 sec, 30 sec. and 3 min.) when receiving an alarm signal.</p>  	<ul style="list-style-type: none"> • When set to 15 sec., recording will take place in 2-hour mode for 15 sec., and return to the previous time mode. • When set to 30 sec., recording will take place in 2-hour mode for 30 sec. • When set to 3 min., recording will take place in 2-hour mode for 3 min. • When alarm recording is completed, the alarm display will blink. • If the ALARM RESET and GROUND terminals are short-circuited, alarm recording will be cancelled. • A voltage of 5 V is fed from the ALARM OUT terminal during an alarm. • When an alarm signal is input with the buzzer switch set to ON, the buzzer sounds continuously.

Notes

- If the alarm input terminals short-circuit for more than the specified time, alarm recording continues during that time.
- During alarm recording, on-screen display appears in two lines.

Basic Playback

Before attempting playback, turn off the **REC LOCK/RESTART** switch.

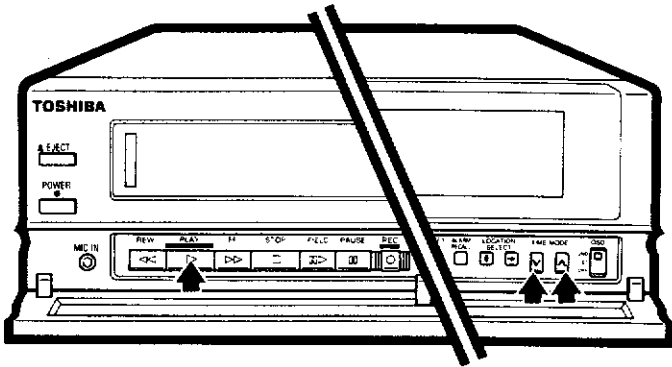

- ① Switch on the power.
- ② Insert the cassette tape.
- ③ Press the **PLAY** button.
- ④ Select the playback time mode.

Notes

- If a power failure occurs with the **REC LOCK/RESTART** switch on, this VCR will enter record mode automatically.
- If the **PAUSE** button is pressed during playback, this machine will pause. To release it, press the **PLAY** button or **PAUSE** button again. If pause is continued for longer than about 10 minutes, this machine will return to the playback state.
- Some tapes may not be played back because of the recording mode in which they were recorded.

Recorded Time Modes	Reproducible Time Modes
2, 12, 24 hours	2, 12, 24 hours

Playback in Various Ways

This VCR is designed to quickly review the contents of recorded tape. Carefully read the following description, and become familiar with the operation, during playback.

Selection	Operation	Function
To playback a tape recorded in time lapse mode.	Set to any one of time modes (12 or 24 hours).	Tape can be played in slow mode.
To quickly check the contents of a tape recorded in time lapse mode.	Select 2 hour mode or press the FF button.	Tape can be played back in quick motion: normal speed or 5 times normal speed.
To playback a tape recorded in time lapse mode.	Press the REW button.	Tape can be played back in reverse quick motion: 5 times normal speed.
To analyze a certain scene during playback.	Press the PAUSE button, then FIELD button.	Fields of the picture can be fed one by one in playback. Keep the FIELD button pressed to slow the playback speed to about 1/30 of the normal speed.
To take a single field.	Press the PAUSE button.	Field still pictures can be obtained.

Playback Adjustment Procedure

Carefully read the following descriptions to obtain optimum performance.

TRACKING

TRACKING

Noise appears in the picture during 2 hour playback.

- Adjust TRACKING to get a clearer picture.

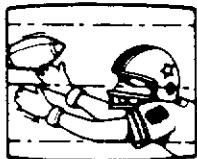

FIELD TRACKING

- Adjust FIELD TRACKING to get a clearer picture when noise appears on the screen in FIELD mode.

Note: Noise appears when a tape recorded in 2-hour mode is played back.

In the case of 12 or 24 hour modes, noise cannot be eliminated by adjusting "TRACKING", "FIELD TRACKING".

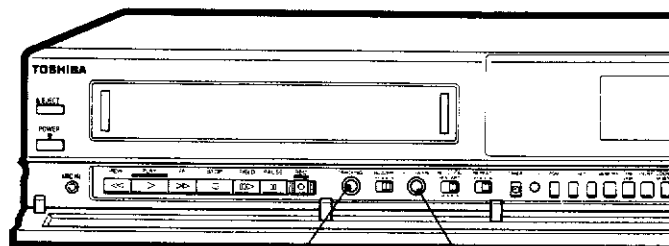

TRACKING FIELD TRACKING

Playback of Alarm Recordings

This VCR is designed for quick review of the contents of the alarm recordings. Carefully read the following descriptions, and become familiar with each operation.

Selection	Operation	Function
To play back a tape immediately after alarm recording or repeatedly play back a certain segment of a tape.	Clear the counter to "0000" by pressing the counter reset button at the point on the tape which you want to check. Press the COUNT. MEMORY button. The counter memory lamp on the mode display will light. In this condition, fast-forward or rewind the tape.	The tape will automatically stop at around "0000".
To quickly review the tape recorded in alarm record mode.	Press the COUNT. MEMORY button to turn on the alarm memory lamp. In this condition, fast-forward or rewind the tape.	Still field mode will automatically start at the point of the tape where the alarm signal is recorded. Press the PAUSE button or PLAY button to start replay.
To quickly find alarm recording date (weekdays)	Press the ALARM RECALL button in stop mode.	Alarm information on AL1 to AL5 (year, month, date, day of the week, hour, minute, second) will automatically appear in sequence on TV display, starting with latest one (AL1) at 5 seconds intervals. After AL5 is displayed, this function is released.
To check the number of alarm recordings	Press the COUNT. button to show the alarm counter on the display panel.	The number of alarm recordings will appear up to "99".

Maintenance

This VCR is designed for long service, but periodic maintenance is recommended to keep it in top condition.

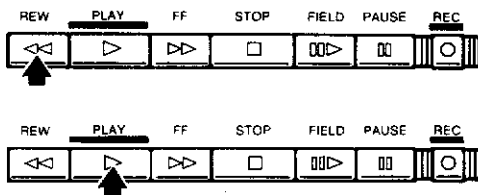
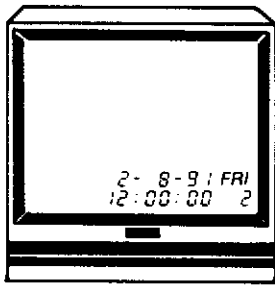

Procedure

- ① Make sure that the **REC LOCK/RESTART** switch is "OFF", and then turn ON the power switches of this VCR, and equipment such as video camera and monitor TV that are connected to the monitoring system.
- ② Make sure that correct pictures can be seen on the monitor TV.
- ③ Check the date and time displayed on the monitor TV.
- ④ Rewind the cassette tape recorded on the previous day by a few counts.
- ⑤ Press the **PLAY** button.
- ⑥ Check the picture played back.
- ⑦ Check the accuracy of the date and time of recording.

Notes

- If any abnormality is found, turn OFF the power switch and disconnect the power plug from the wall receptacle.
- The **REC** lamp also blinks when there is an abnormality in the VCR. The lamp will not go off even if one of the operation buttons is pressed.

Operating Precautions

About Dewing

In case of dew detection (excessive moisture in the unit), the safety device will operate to protect the cassette tape and video head from damage.

In case of dew detection

The "DEW" message blinks, and buzzer sounds continuously (when **BUZZER** switch is ON.) To stop the buzzer, turn the **BUZZER** switch off.

Take out the video cassette

Wait until the "DEW" message goes out with the **POWER** switch turned "ON". It may take a few hours, although it depends upon conditions.

- Dew accumulation is similar to the phenomenon that occurs when water gathers on a window glass of a heated room during the winter season.
- If the VCR operates in dewing condition, the tape and video head will be damaged.
- Dewing is likely to occur:
 - When the VCR is rapidly moved from a cold place to warm place.
 - In rooms immediately after being heated or in places subjected directly to cold air from an air-conditioner.
 - In summer, when the VCR is rapidly moved from a cooled room or car to a hot, humid place.
 - In very humid rooms.

Before Calling Service Personnel

Check the following points once again.

Installation	
Power is not supplied.	<ul style="list-style-type: none"> • Check that power cord plug is properly connected to an AC outlet.
E.E pictures do not appear.	<ul style="list-style-type: none"> • Check the connection of this unit to TV and video camera. • Check for defective cable.
Function/Operation	
No operation with button pressed.	<ul style="list-style-type: none"> • Check if the video cassette is loaded correctly. • Check if REC LOCK/RESTART switch is "OFF". • Check for blinking of Dew lamp.
Dew lamp is blinking.	<ul style="list-style-type: none"> • The unit does not operate because a safety device is actuated. Wait until the lamp goes out.
Date and time display data are not memorised, in case of power failure.	<ul style="list-style-type: none"> • Check if the power cord plug of this unit is disconnected from the outlet for a long period of time. Connect the power cord plug of this unit to an AC outlet to charge it for at least 20 hours consecutively.
Recording	
Playback, fast forward and rewind are possible, but recording is not possible. Recording is discontinued.	<ul style="list-style-type: none"> • Check that the video cassette safety tab is not broken. • Check if video cassette tape is at the end. • Check if more than 10 minutes has passed after pressing PAUSE button during recording.
Power failure is over, but recording is not resumed.	<ul style="list-style-type: none"> • Check if the REC LOCK/RESTART switch is "OFF". • Check that power failure period exceeds 7 days.
Repeat recording is not possible.	<ul style="list-style-type: none"> • Check that REPEAT switch is "ON". • Check if [ALARM] is displayed. • Check if STOP button was pressed during auto rewind mode.
Buzzer does not sound.	<ul style="list-style-type: none"> • Check if the BUZZER switch is "OFF".
Timer recording is not possible.	<ul style="list-style-type: none"> • Check if the present time is correct. • Check if the Timer is programmed correctly. • Check if the TIMER button is pressed. • After timer recording time setting: <ul style="list-style-type: none"> • Power failure took place? • Power switch turned "OFF"? • Power cord plug disconnected?
Alarm recording is not possible.	<ul style="list-style-type: none"> • Check that alarm sensor is correctly connected to ALARM IN terminal. • Check if alarm reset input and ground terminal is inadvertently connected.
Playback	
Pictures played back include noise.	<ul style="list-style-type: none"> • Adjust by Tracking Control. • Clogging, deterioration or life of video head is exceeded.
Pictures played back flicker (snow).	<ul style="list-style-type: none"> • Check for dirt on the video head.
Date and time are not displayed in the pictures recorded tape.	<ul style="list-style-type: none"> • Check if the OSD switch was "OFF" in recording mode.
When the power cord of the recorder is plugged in the outlet, recording begins but playback operation is not possible.	<ul style="list-style-type: none"> • Check if the REC LOCK/RESTART switch is "ON".

Specifications

Power supply	120V, AC 60 Hz
Power consumption	20 W
External dimensions	430 mm x 88 mm x 354 mm (16-15/16 x 3-7/15 x 13-15/16 inch) (W x H x D)
Weight	6.8 kg (15 lbs)
Signal system	Standard NTSC color television system
Recording system	Rotary 2-head azimuth
Cassette in use	VHS marked, 1/2 inch cassette tape
Tape speed	33.4 mm/sec (at 2 hours record/playback time)
Video record time	2, 12, 24 hours (when T-120 is used)
Playback time	2, 12, 24 hours (when T-120 is used)
Fast forward/rewind time	Within 6 minutes (when T-120 is used)
Video input	1 Vp-p, 75 ohm, unbalanced, negative sync. BNC
Video output	1 Vp-p, 75 ohm, unbalanced, negative sync. BNC
Horizontal resolution	350 lines (monochrome mode). 300 lines (color mode)
Video S/N	More than 45 dB
Audio inputs	Line input: -10 dBs (245mVrms), 47 k-ohm, pin jack - Microphone input: -70 dBs, less than 5 k-ohm, mini jack
Audio output	-7 dBs (346mVrms), less than 10 k-ohm, pin jack
No. of audio tracks	1 track
Audio frequency characteristics	100 Hz to 10 kHz
Audio S/N	More than 43 dB
Permissible operating temperature	41°F to 104°F (5°C to 40°C)
Permissible operating humidity	Less than 80%
Permissible storage temperature	-4°F to 140°F (-20°C to 60°C)
Time date generator	
Display	Month, day, year, day of the week, hour, minute, second, recording mode, alarm recall, alarm display, timer programming.
Display position	Adjustable
Character size	14 x 10H
Power failure backup	About 7 days
Display panel	
Display	Tape, counter memory, recording, alarm memory, alarm, power failure, time, playback, mode, counter, alarm counter, dewing, timer, Detection of abnormality
Alarm	
Alarm input	Shortcircuit
Alarm reset input	Shortcircuit
Alarm recording time	15 sec., 30 sec., 3 min.
Alarm output	5V, impedance 1.3 kΩ

Designs and specifications are subject to change without notice.